

## TAVOLI SCRIVANIA DESKS

## SUPPORTI PER INFORMATICA COMPUTER AND PRINTER TABLES

## TAVOLI DATILO / ALLUNGHI TYPING TABLES / EXTENSIONS

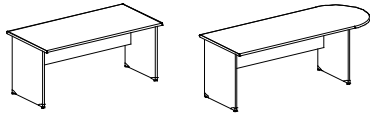

L. 130 / 160 / 180 - P. 80 - H. 72 cm. L. 200 - P. 80 - H. 72 cm.

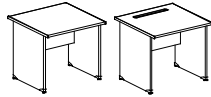

L. 80 - P. 80 - H. 72 cm.

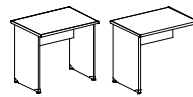

L. 80 - P. 60 - H. 72 cm.

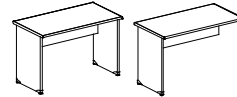

L. 110 - P. 50 / 60 - H. 65 / 72 cm.

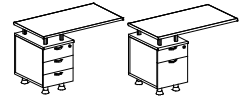

L. 110 - P. 60 - H. 72 cm.

## TAVOLI SCRIVANIA SAGOMATI SHAPED DESKS

## CASSETTIERE PEDESTALS

## ELEMENTO DI SERVIZIO SERVICE UNIT

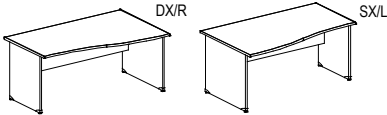

L. 160 - P. 80 / 100 - H. 72 cm.



L. 25 - P. 39  
H. 23 cm.



L. 42 - P. 53  
H. 35 cm.



L. 42,5 - P. 57,5 - H. 56 cm.

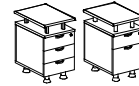

L. 42,5 - P. 60 - H. 72 cm.



L. 90 - P. 60 - H. 65 cm.

## TAVOLI COMPATTI DX O SX COMPACT DESKS (R OR L)

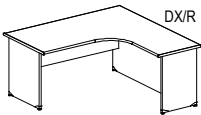

L. 161 - P. 161 - H. 72 cm.

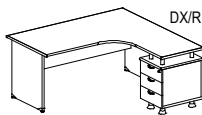

L. 161 - P. 161 - H. 72 cm.

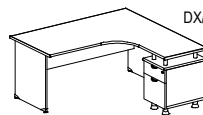

L. 161 - P. 161 - H. 72 cm.

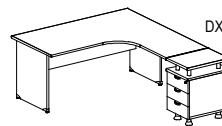

L. 161 - P. 203,5 - H. 72 cm.

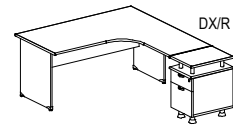

L. 161 - P. 203,5 - H. 72 cm.

## TAVOLI RIUNIONE CONFERENCE TABLES

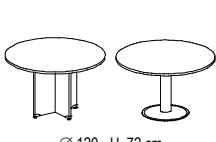

Ø 120 - H. 72 cm.

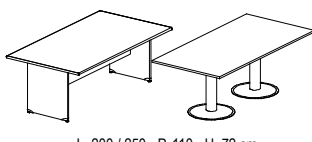

L. 200 / 250 - P. 110 - H. 72 cm.

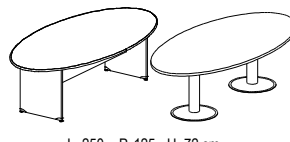

L. 250 - P. 125 - H. 72 cm.



L. 310 / 360 - P. 110 - H. 72 cm.



L. 206 / 236 / 296 / 326 / 346  
P. 126 / 166 - H. 72 cm.

## RACCORDI CONNECTION ELEMENTS

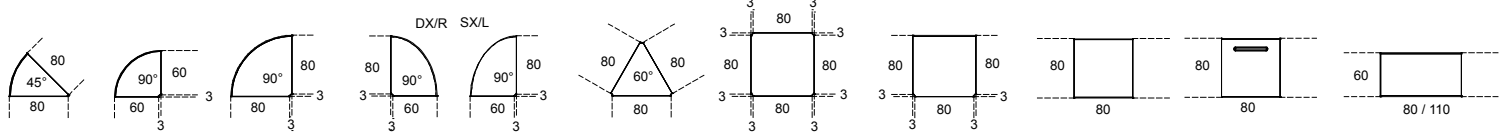

## RACCORDI SU COLONNA O GAMBONE CONNECTION ELEMENTS WITH SLIM COLUMN OR COLUMN

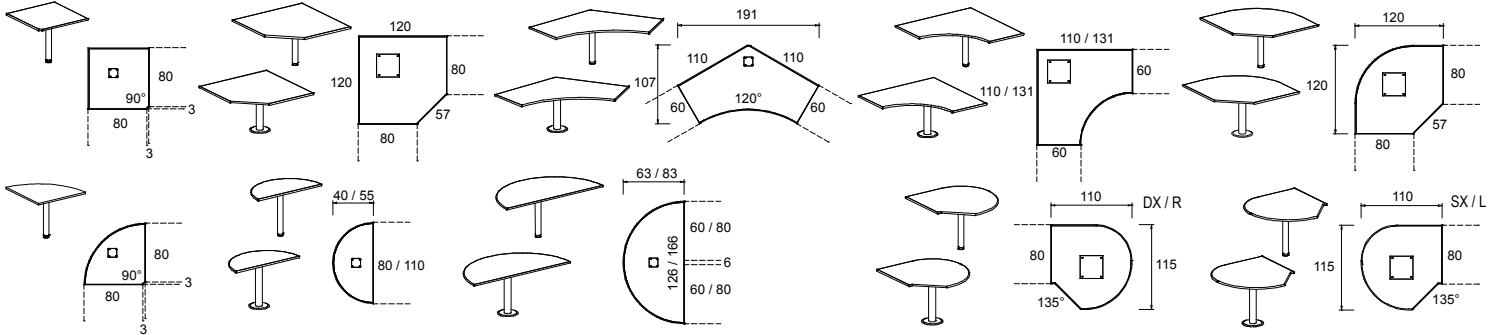

## FRONTAL PANELS

## MENSOLE SHELVES

## MENSOLE E FRONTAL PANELS SHELVES WITH FRONTAL PANELS

## BARRE PORTACCESSORI ACCESSORY HOLDER BARS

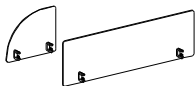

L. 60 / 80 / 100 / 110 / 120 / 130 / 160 / 180 - H. 48 cm.



L. 110 / 130 / 160 / 180 - P. 30 - H. 27 cm.

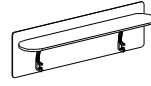

L. 110 / 130 / 160 / 180 - P. 31 - H. 48 cm.

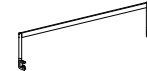

L. 80 / 130 / 160 - P. 3 - H. 37 cm.



L. 80 / 130 / 160 - P. 3 - H. 43 cm.

## CONTENITORI STORAGE UNITS

## CONTENITORI GUARDAROBA WARDROBE UNITS

Contenitori previsti:  
a giorno, con ante piene, ante vetro,  
cassetti e cassetti classificatori

Types of storage units available:  
open unit - with wooden doors -  
with glass doors - with drawers -  
with filing drawers

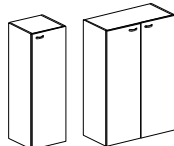
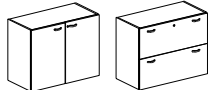
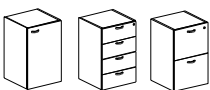

L. 45 / 90 - P. 45 - H. 73,5 / 136 / 206,5 cm.

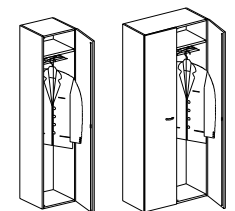
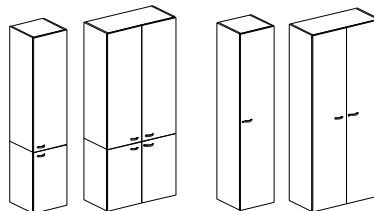

L. 60 / 90 - P. 45 - H. 206,5 cm.

N.B. Consultare il listino prezzi per le caratteristiche tecniche, i codici degli articoli e le finiture.  
N.B. For technical characteristics, article code numbers and finishes, see price list.